



OUTSIDE MICROMETERS WITH COUNTER

- Counter resolution: 0.01mm
- Thimble graduation: 0.01mm
- Carbide measuring faces
- Meet DIN 863-1
- Ratchet stop
- Supplied with setting standards (except 0-25mm)

Code	Range	Accuracy	L	a	b
3400-25*	0-25mm	4µm	32mm	6mm	26mm
3400-50*	25-50mm	4µm	57mm	8mm	32mm
3400-75*	50-75mm	5µm	82mm	8mm	44.5mm
3400-100*	75-100mm	5µm	107mm	8mm	57mm

*Supplied with manufacturer inspection certificate traceable to DKD Germany



3400-25

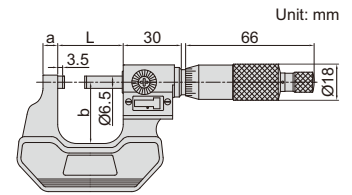

5

QUICK FEEDING OUTSIDE MICROMETERS

- Graduation 0.01mm
- 1mm feeding of each turn
- Friction thimble
- Carbide measuring faces
- Meet DIN863-1
- Supplied with setting standards (except 0-25mm)

Code	Range	Accuracy	L	a	b
3208-25B	0-25mm	4µm	32mm	6mm	24mm
3208-50B	25-50mm	4µm	57mm	8mm	32mm
3208-75B	50-75mm	5µm	82mm	8mm	45mm
3208-100B	75-100mm	5µm	107mm	8mm	57mm
3208-125B	100-125mm	6µm	133mm	8mm	70mm
3208-150B	125-150mm	6µm	158mm	8mm	82mm
3208-175B	150-175mm	7µm	183mm	8mm	95mm
3208-200B	175-200mm	7µm	209mm	8mm	107mm



3208-25B

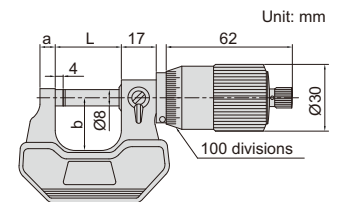

OUTSIDE MICROMETERS

Individual

Code	Range	Accuracy	L	a	b
3202-25A*	0-25mm	4µm	32mm	6mm	24mm
3202-50A*	25-50mm	4µm	57mm	8mm	32mm
3202-75A*	50-75mm	5µm	82mm	8mm	45mm
3202-100A*	75-100mm	5µm	107mm	8mm	57mm
3202-125A	100-125mm	6µm	133mm	8mm	70mm
3202-150A	125-150mm	6µm	125mm	8mm	82mm
3202-175A	150-175mm	7µm	183mm	8mm	95mm
3202-200A	175-200mm	7µm	209mm	8mm	107mm

Set

Code	Range	Micrometers included
3202-753A*	0-75mm	3202-25A, 3202-50A, 3202-75A
3202-1004A*	0-100mm	3202-25A, 3202-50A, 3202-75A, 3202-100A
3202-1506A	0-150mm	3202-25A, 3202-50A, 3202-75A, 3202-100A, 3202-125A, 3202-150A

*Supplied with manufacturer inspection certificate traceable to DKD Germany



3202-25A

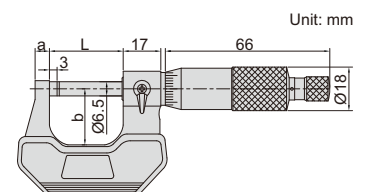

- Graduation 0.01mm
- Carbide measuring faces
- Meet DIN863-1
- Supplied with setting standards (except 0-25mm)

OUTSIDE MICROMETERS



5



3203-25A



3203-50A



3203-1004A



3203-3006A

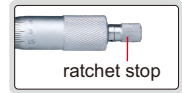

- Graduation: metric 0.01mm
inch 0.0001"
- Carbide measuring faces
- Meet DIN863-1
- Supplied with setting standards (except 0-25mm and 0-1")

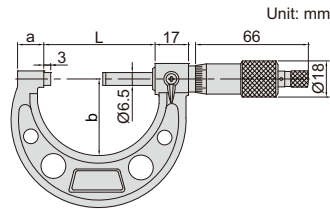

Metric (ratchet stop type)

Code	Range	Accuracy	L	a	b
3203-25A*	0-25mm	±2µm	32mm	9mm	28mm
3203-50A*	25-50mm	±2µm	57mm	14mm	38mm
3203-75A*	50-75mm	±2µm	82mm	15mm	49mm
3203-100A*	75-100mm	±3µm	107mm	15mm	60mm
3203-125A	100-125mm	±3µm	133mm	16.5mm	73mm
3203-150A	125-150mm	±3µm	158mm	16.5mm	85mm
3203-175A	150-175mm	±4µm	183mm	19.4mm	104mm
3203-200A	175-200mm	±4µm	209mm	19.4mm	117mm
3203-225A	200-225mm	±4µm	234mm	19.4mm	130mm
3203-250A	225-250mm	±5µm	260mm	19.4mm	142mm
3203-275A	250-275mm	±5µm	285mm	19.4mm	155mm
3203-300A	275-300mm	±5µm	310mm	19.4mm	168mm

Inch (ratchet stop type)

Code	Range	Accuracy	L	a	b
3203-1A*	0-1"	±0.0001"	1.260"	0.354"	1.102"
3203-2A*	1-2"	±0.0001"	2.244"	0.551"	1.496"
3203-3A*	2-3"	±0.0001"	3.228"	0.591"	1.929"
3203-4A*	3-4"	±0.00015"	4.213"	0.591"	2.362"
3203-5A*	4-5"	±0.00015"	5.236"	0.650"	2.874"
3203-6A*	5-6"	±0.00015"	6.220"	0.650"	3.346"
3203-7A	6-7"	±0.0002"	7.205"	0.764"	4.094"
3203-8A	7-8"	±0.0002"	8.228"	0.764"	4.606"
3203-9A	8-9"	±0.0002"	9.213"	0.764"	5.118"
3203-10A	9-10"	±0.00025"	10.236"	0.764"	5.591"
3203-11A	10-11"	±0.00025"	11.220"	0.764"	6.102"
3203-12A	11-12"	±0.00025"	12.205"	0.764"	6.614"

Metric micrometer set (ratchet stop type)

Code	Range	Micrometers Included	Packaging
3203-753A*	0-75mm	3203-25A, 3203-50A, 3203-75A	blow mould case
3203-1004A*	0-100mm	3203-25A, 3203-50A, 3203-75A, 3203-100A	blow mould case
3203-1506A	0-150mm	3203-25A, 3203-50A, 3203-75A, 3203-100A, 3203-125A, 3203-150A	blow mould case
3203-3006A	150-300mm	3203-175A, 3203-200A, 3203-225A, 3203-250A, 3203-275A, 3203-300A	aluminum box
3203-3012A	0-300mm	3203-25A, 3203-50A, 3203-75A, 3203-100A, 3203-125A, 3203-150A, 3203-175A, 3203-200A, 3203-225A, 3203-250A, 3203-275A, 3203-300A	aluminum box

Inch micrometer set (ratchet stop type)

Code	Range	Micrometers included	Packaging
3203-33A*	0-3"	3203-1A, 3203-2A, 3203-3A	blow mould case
3203-44A*	0-4"	3203-1A, 3203-2A, 3203-3A, 3203-4A	blow mould case
3203-66A*	0-6"	3203-1A, 3203-2A, 3203-3A, 3203-4A, 3203-5A, 3203-6A	blow mould case
3203-126A	6-12"	3203-7A, 3203-8A, 3203-9A, 3203-10A, 3203-11A, 3203-12A	aluminum box
3203-1212A	0-12"	3203-1A, 3203-2A, 3203-3A, 3203-4A, 3203-5A, 3203-6A, 3203-7A, 3203-8A, 3203-9A, 3203-10A, 3203-11A, 3203-12A	aluminum box

Inch (friction thimble type)

Code	Range	Accuracy	L	a	b
3203-1FA*	0-1"	±0.0001"	1.260"	0.354"	1.102"
3203-2FA*	1-2"	±0.0001"	2.244"	0.551"	1.496"
3203-3FA*	2-3"	±0.0001"	2.244"	0.591"	1.929"

* Supplied with manufacturer inspection certificate traceable to DKD Germany or NIST USA

LONG SPINDLE OUTSIDE MICROMETERS

- Graduation 0.01mm
- Carbide measuring faces
- Meet DIN863-1
- Ratchet stop
- Supplied with setting standards (except 0-25mm)

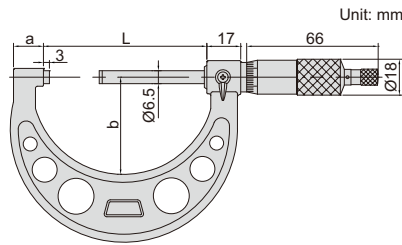

3209-25

5

Code	Range	Accuracy	L	a	b
3209-25	0-25mm	4µm	57mm	14mm	38mm
3209-50	25-50mm	4µm	82mm	15mm	49mm
3209-75	50-75mm	5µm	107mm	15mm	60mm
3209-100	75-100mm	5µm	133mm	16.5mm	73mm

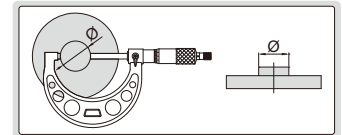
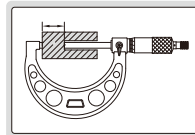

NON MAGNETIC MICROMETERS

- Suitable for magnetic materials
- Graduation: 0.01mm
- Non magnetic carbide measuring faces
- Ratchet stop



3231-25A

Code	Range	Accuracy	L	b
3231-25A	0-25mm	4µm	32mm	24mm
3231-50A	25-50mm	4µm	57mm	32mm
3231-75A	50-75mm	5µm	82mm	45mm
3231-100A	75-100mm	5µm	105mm	57mm

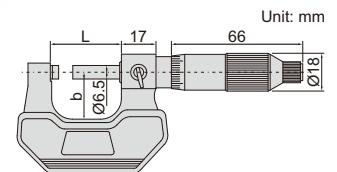

OUTSIDE MICROMETERS FOR LEFT OR RIGHT HANDERS

- Graduation 0.01mm
- Graduations on two sides
- Ratchet stop
- Carbide measuring faces
- Meet DIN863-1
- Supplied with setting standards (except 0-25mm)



front



back

3236-25B

Code	Range	Accuracy	L	a	b
3236-25B	0-25mm	4µm	32	6	24
3236-50B	25-50mm	4µm	57	8	32
3236-75B	50-75mm	5µm	82	8	45
3236-100B	75-100mm	5µm	107	8	57
3236-125B	100-125mm	6µm	133	8	70
3236-150B	125-150mm	6µm	158	8	82
3236-175B	150-175mm	7µm	183	8	95
3236-200B	175-200mm	7µm	209	8	107

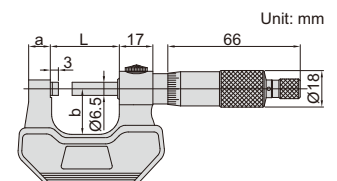

1µm GRADUATION OUTSIDE MICROMETERS

- Graduation 0.001mm
- Carbide measuring faces
- Meet DIN863-1
- Supplied with setting standards (except 0-25mm)

**INSPECTION
CERTIFICATE**
TRACEABLE TO DKD



3210-25A

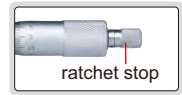
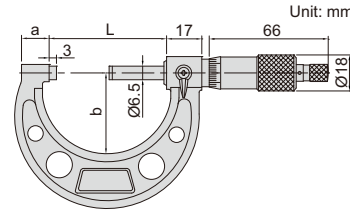

Ratchet stop type

Code	Range	Accuracy	L	a	b
3210-25A*	0-25mm	4µm	32	9	28
3210-50A*	25-50mm	4µm	57	14	38
3210-75A*	50-75mm	5µm	82	15	49
3210-100A*	75-100mm	5µm	107	15	60
3210-125A	100-125mm	6µm	133	16.5	73
3210-150A	125-150mm	6µm	158	16.5	85
3210-175A	150-175mm	7µm	183	19.4	104
3210-200A	175-200mm	7µm	209	19.4	117

Friction thimble type

Code	Range	Accuracy	L	a	b
3210-25FA*	0-25mm	4µm	32	9	28
3210-50FA*	25-50mm	4µm	57	14	38

Micrometer set (ratchet stop type)

Code	Range	Micrometers included
3210-753A*	0-75mm	3210-25A, 3210-50A, 3210-75A
3210-1004A*	0-100mm	3210-25A, 3210-50A, 3210-75A, 3210-100A
3210-1506A	0-150mm	3210-25A, 3210-50A, 3210-75A, 3210-100A, 3210-125A, 3210-150A

*Supplied with manufacturer inspection certificate traceable to DKD Germany

5

OUTSIDE MICROMETERS WITH EXTENSION ANVIL COLLAR

- Graduation 0.01mm
- Adjust collars for different measuring ranges
- Ratchet stop
- Carbide measuring faces
- Supplied with setting standards



adjust collars for different measuring ranges

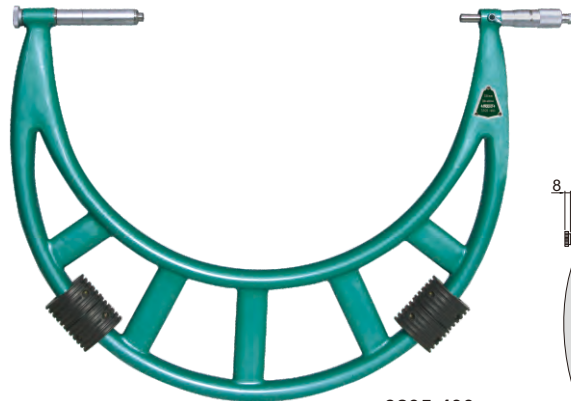

3205-400

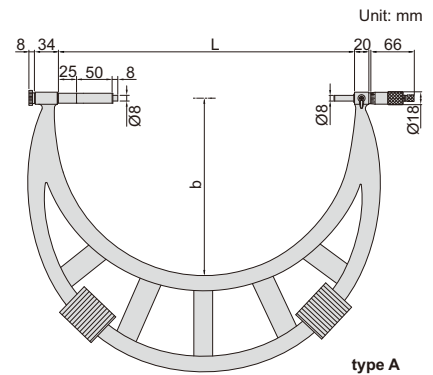

type A

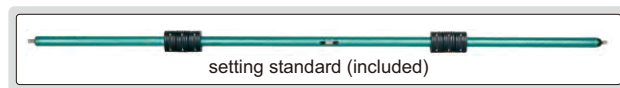

Code	Range	Type	Accuracy	L	b	Setting standard (included)
3205-400	300-400mm	A	11µm	410	250	325, 375
3205-500	400-500mm	A	13µm	510	295	425, 475
3205-600	500-600mm	A	14µm	610	345	525, 575
3205-700	600-700mm	A	16µm	710	395	625, 675
3205-800	700-800mm	A	18µm	810	445	725, 775,
3205-900	800-900mm	A	20µm	910	495	825, 875
3205-1000	900-1000mm	A	22µm	1010	545	925, 975
3205-1200	1000-1200mm	B	22µm	1210	645	1050, 1150
3205-1400	1200-1400mm	B	24µm	1410	745	1250, 1350
3205-1600	1400-1600mm	B	28µm	1610	845	1450, 1550
3205-1800	1600-1800mm	B	31µm	1810	945	1650, 1750
3205-2000	1800-2000mm	B	34µm	2010	1045	1850, 1950

(mm)

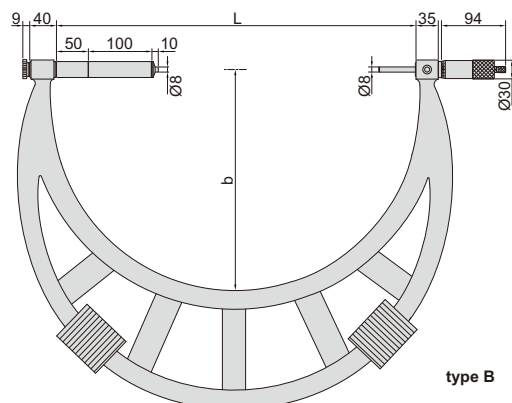

type B

OUTSIDE MICROMETERS WITH INTERCHANGEABLE ANVILS

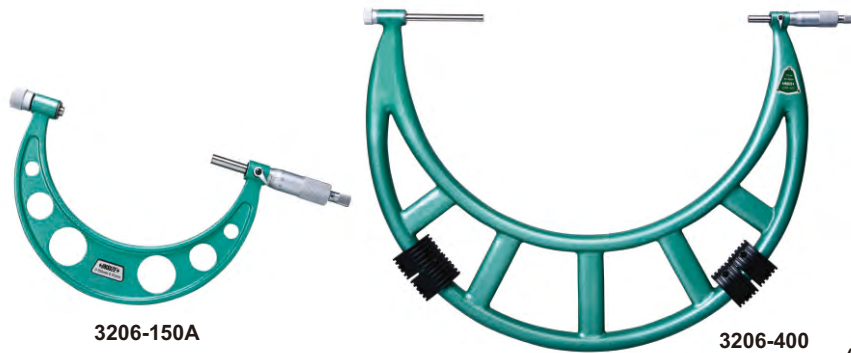

- Graduation 0.01mm
- Ratchet stop
- Meet DIN863-3
- Carbide measuring faces
- Supplied with setting standards

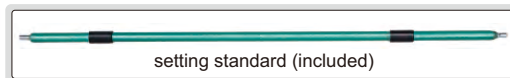
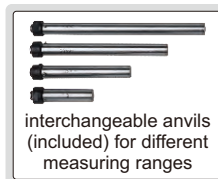

5

Code	Range	Type	Accuracy	L	b	Setting standard (included)
3206-50A	0-50mm	A	4µm	58	35	25
3206-100A	0-100mm	A	5µm	108	57	25, 50, 75
3206-150A	0-150mm	A	6µm	158	82	25, 50, 75, 100, 125
3206-151A	50-150mm	A	6µm	158	82	50, 75, 100, 125
3206-200A	100-200mm	A	7µm	208	114	100, 125, 150, 175
3206-300A	150-300mm	A	9µm	308	165	150, 175, 200, 225, 250, 275
3206-301A	200-300mm	A	9µm	308	165	200, 225, 250, 275
3206-400	300-400mm	B	11µm	409	224	325, 375
3206-500	400-500mm	B	13µm	509	275	425, 475
3206-600	500-600mm	B	14µm	609	321	525, 575
3206-700	600-700mm	B	16µm	709	371	625, 675
3206-800	700-800mm	B	18µm	809	426	725, 775
3206-900	800-900mm	B	20µm	909	476	825, 875
3206-1000	900-1000mm	B	22µm	1009	576	925, 975

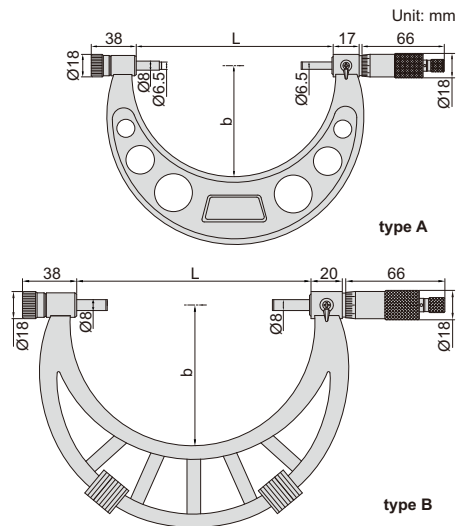

IP65
WATERPROOF

DATA
OUTPUT

DIGITAL OUTSIDE MICROMETERS WITH INTERCHANGEABLE ANVILS

- Resolution 0.001mm/0.0001" (resolution of 3506-100A and 3506-150A is 0.001mm/0.00005")
- IP65 dust/waterproof
- Button function: on/off, set, mm/inch, ABS/INC
- Data output
- Automatic power off
- Ratchet stop
- Carbide measuring faces
- Supplied with setting standards
- Optional accessory: data output cable (code 7315-30, 7302-30)

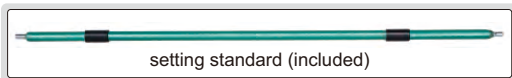
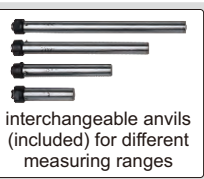
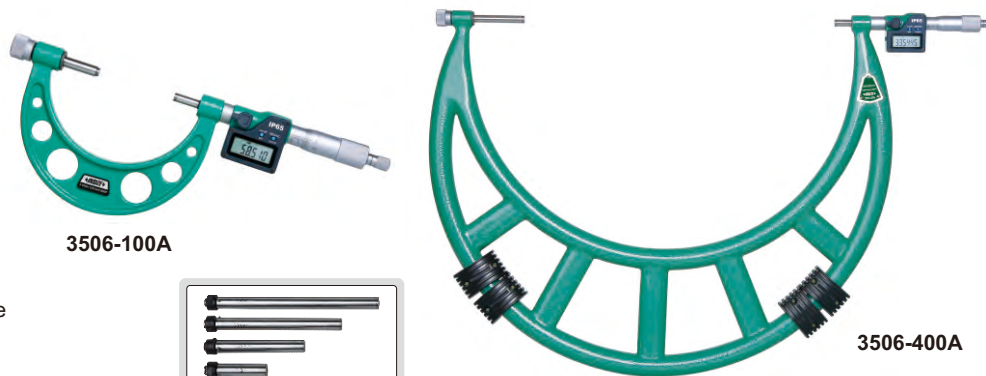

Code	Range	Type	Accuracy	L	b	Setting standard (included)
3506-100A	0-100mm/0-4"	A	±5µm	105	57	25, 50, 75
3506-150A	0-150mm/0-6"	A	±6µm	155	82	25, 50, 75, 100, 125
3506-300A	150-300mm/6-12"	A	±8µm	305	165	150, 175, 200, 225, 250, 275
3506-301A	200-300mm/8-12"	A	±8µm	305	165	200, 225, 250, 275
3506-400A	300-400mm/12-16"	B	±9µm	405	224	325, 375
3506-500A	400-500mm/16-20"	B	±11µm	505	275	425, 475
3506-600A	500-600mm/20-24"	B	±12µm	605	321	525, 575
3506-700A	600-700mm/24-28"	B	±13µm	705	371	625, 675
3506-800A	700-800mm/28-32"	B	±15µm	805	426	725, 775
3506-900A	800-900mm/32-36"	B	±16µm	905	476	825, 875
3506-1000A	900-1000mm/36-40"	B	±17µm	1005	576	925, 975

